

THE AQUA CREEK PRODUCTS ADA TRANSFER RAIL MEASURES 5" ABOVE THE FINISHED SURFACE. THE ADA TRANSFER RAIL IS DESIGNED TO RUN PARALLEL TO THE DECK SURFACE.

THE AQUA CREEK PRODUCTS ADA TRANSFER RAIL SHALL BE FABRICATED OF 1.50" O.D. X .120" WALL THICKNESS 316L STAINLESS STEEL. THE TRANSFER RAIL SHALL BE POLISHED TO A NEAR #7 FINISH OR A 600 GRIT.

THE AQUA CREEK PRODUCTS ADA TRANSFER RAIL SHALL BE SUPPORTED BY FOUR (4) DROP IN ANCHORS (INCLUDED), AND SHALL BE COVERED BY TWO (2) SPLIT STAINLESS STEEL ESCUTCHEONS (INCLUDED).

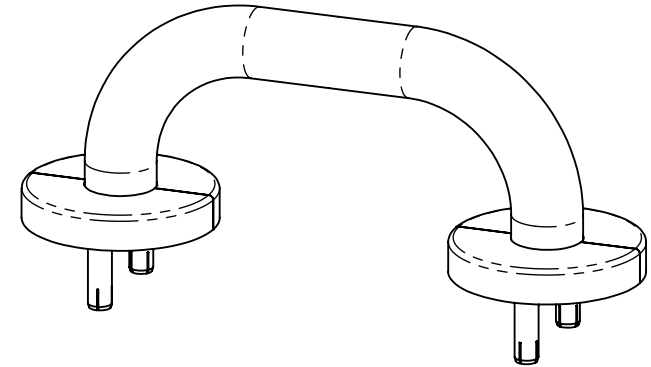
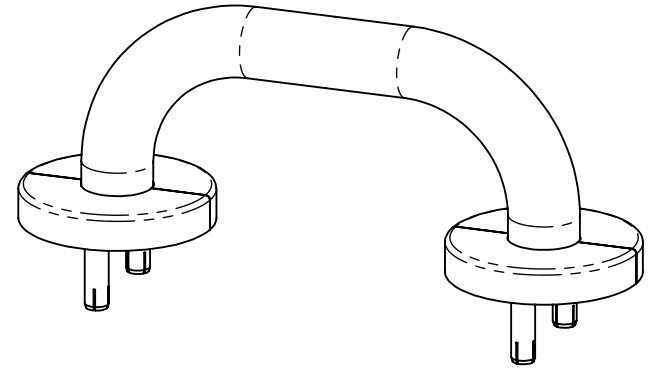
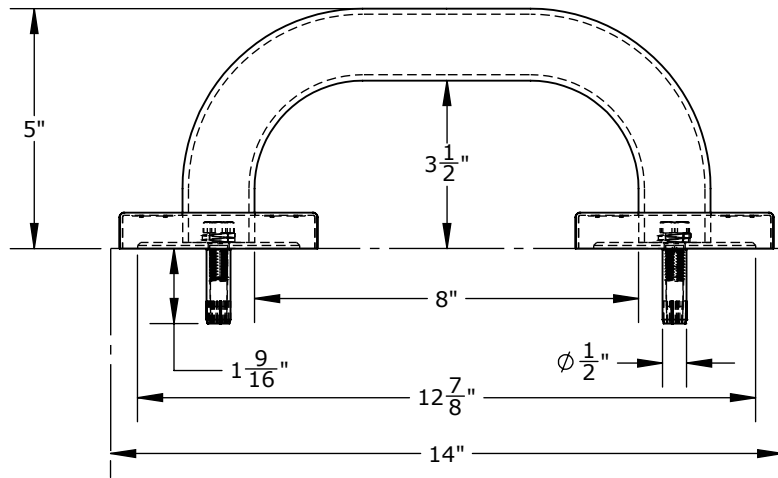
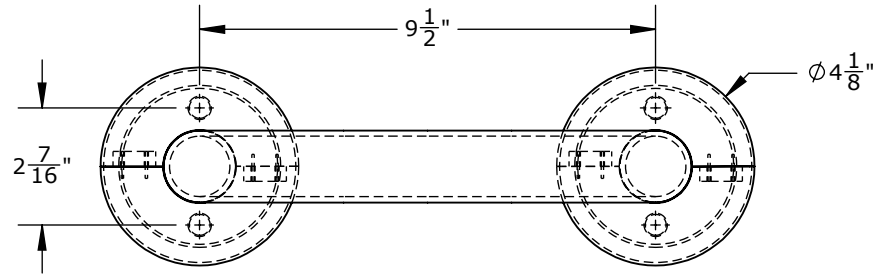

TRUPRO - ADA TRANSFER GRAB RAIL - 14.00" X 1.50 OD X .120 WALL 316LSS - W/FLANGE

CATALOG NO. TTR-FG14-461
PART NO. INV03756



9889 GARRYMORE LANE
MISSOULA, MT 59808
(406) 549-0769
FAX (406) 549-2602
www.AquaCreek.com

PROPRIETARY AND CONFIDENTIAL INFORMATION

THIS DRAWING AND ALL INFORMATION CONTAINED HEREIN IS THE SOLE PROPERTY OF AQUA CREEK PRODUCTS LLC. ANY REPRODUCTION IN PART OR AS A WHOLE WITHOUT WRITTEN PERMISSION FROM AQUA CREEK IS PROHIBITED.

*SPECIFICATIONS ARE SUBJECT TO CHANGE WITHOUT NOTICE

DIMENSIONS ARE IN INCHES
UNLESS OTHERWISE SHOWN
FRACTIONAL: ±1/16
ANGULAR: ±1°
TWO PLACE DECIMAL: ±.01
THREE PLACE DECIMAL: .. ±.005

MATERIAL: 316L STAINLESS STEEL
FINISH: NEAR #7 OR 600 GRIT
APPROX. WEIGHT: 4.02 LBS.

MODEL
1

TRUPRO - ADA TRANSFER GRAB RAIL - 14.00" X 1.50 OD X .120 WALL 316LSS - W/FLANGE - INV03756

SCALE
1:4
SHEET
1